

NM SERIES

End Suction Norm Centrifugal Pumps



Operating Manual



EC DECLARATION OF CONFORMITY

AT UYGUNLUK BEYANI

Manufacturer / İmalatçı : MAS DAF MAKİNA SANAYİ A.Ş.

Address / Adres : Aydınlı Mah. Birlik OSB. 1.No'lu Caddesi No:17 Tuzla - İSTANBUL / TÜRKİYE

Name and address of the person authorised to compile the technical file : Vahdettin YIRTMAÇ
Aydınli Mah. Birlik OSB. 1.No'lu Caddesi No:17
Teknik Dosyaya Derleyen Yetkili Kişi ve Adresi : Tuzla - İSTANBUL / TÜRKİYE

The undersigned Company certifies under its sole responsibility that the item of equipment specified below satisfies the requirements of the mainly Machinery Directive 2006/42/EC which is apply to it.

The item of equipment identified below has been subject to internal manufacturing checks with monitoring of the final assessment by MAS DAF MAKİNA SANAYİ A.Ş.

Aşağıda tanımlanmış olan ürünler için Makine Emniyeti yönetmeliği 2006 / 42 / AT' nin uygulanabilen gerekliliklerinin yerine getirildiğini ve sorumluluğunun alınmış olduğunu beyan ederiz.

Aşağıda tanımlanan ürünler iç üretim kontrollerine bağlı olarak MAS DAF MAKİNA SANAYİ A.Ş. tarafından kontrol edilmiştir.

Equipment / Ürün : End Suction Norm Centrifugal Pumps / Uçtan Emişli Norm Santrifuj Pompalar

Seri / Model-Tip : NM Series - NM Serisi

For pumps supplied with drivers/ Elektrikli Pompa Üniteleri

Related Directives / Yönetmelikler

2006/42/EC Machinery Directive / 2006/42/AT Makine Emniyeti Yönetmeliği

2014/35/EU Low Voltage Directive / 2014/35/AB Alçak Gerilim Yönetmeliği

2014/30/EU Electromagnetic Compatibility Directive / 2014/30/AB Elektromanyetik Uyumluluk Yönetmeliği

EUP 2009/ 125 /EC Electric Used Products Directive/ Elektrik Kullanan Ekipmanlar Direktifi (EUP)

94/9/EC Equipment For Explosive Atmospheres / Patlayıcı Ortamlardaki Ekipman Yönetmeliği (EUP)

2009/125/EC European Ecodesign Directive, Regulation No: 547/2012 Ecodesign Requirements for Water Pumps / Avrupa

Ekotasarım Direktifi, (SGM-2015/44) 547/2012 No'lu Su Pompalarında Ekotasarım Regülasyonu

Regulations applied acc. to harmonize standards / Uygulanan Uyumlaştırılmış Standartlar

TS EN ISO 12100:2010, TS EN 809+A1, TS EN 60204-1:2018.

We hereby declare that this equipment is intended to be incorporated into, or assembled with other machinery to constitute relevant machinery to comply with essential health and safety requirements of Directive. The machinery covered by this declaration must not be put into service until the relevant machinery into which it is to be incorporated has been declared in conformity with provisions of the directive.

Ekipman, uygun bir makina oluşturmak amacıyla diğer ekipmanlar ile birleştirilirken ya da monte edilirken gerekli sağlık ve güvenlik yönetmeliklerine uyulması gerekmektedir.

Bu bildiri kapsamında yönetmelikte belirtilen bütün hükümler yerine getirilmeden makinanın devreye alınmaması gerekmektedir.

Place and date of issue / Yer ve Tarih : İstanbul, 01.08.2019

Name and position of authorized person : Vahdettin YIRTMAÇ
Genel Müdür / Genel Müdür

Signature of authorized person :

Yetkili Kişinin İmzası

TABLE OF CONTENTS

Page No

Introduction	3
1. Important Safety Precautions	3
2. General	4
3. Safe Operating Conditions	5
4. Technical Information	5
5. Transport and Storage	6
6. Assembly/Installation	7
6.1. Installation	7
6.2. Type of Connection	7
6.3. Foundation	7
6.4. Coupling Alignment	8
6.5. Piping	9
6.6. Motor Connection	10
7. Commissioning, Start up and Operating	11
7.1. Preparations Before Start up	11
7.2. Checking The Direction of Rotation	11
7.3. Start up Procedure	11
7.4. Shut Down Procedure	11
8. Maintenance	12
8.1. The Checks During the Operation	12
8.2. Service	13
8.3. Spare Parts	13
9. Noise Level and Vibration	13
10. Disassembly, Repair and Reassembly	14
11. Possible Failures, Causes, Solutions	17
12. Pump Dimensions Table and Weight	18
13. Tightening Torques	19
14. Forces And Moments at The Pump Flanges	20
15. Sample Plumbing	22
16. NM Sectional Drawing and Part List	23
17. Alternative Applications	24
18. NM Drawing for Dismantling	25
19. NM Series MEI Values Table	26
20. Figure List	27
21. Table List	27

INTRODUCTION



- This manual contains instructions for the installation, operation and maintenance of the NM type single stage centrifugal pumps of **MAS DAF MAKINA SANAYI A.Ş.**
- Please read carefully this manual and apply all the instructions to operate pumps without problems. Pumps shall be used for their intended duties. In this manual, there are information on operating conditions, installation, starting-up, settings and main controls of pumps.
- These operating and maintenance instructions contain **MAS DAF MAKINA SANAYI A.Ş.**'s suggestions. The special operating and maintenance information of the plumbing that a pump is fitted to is not considered in these instructions. This information must be given by the plumbing constructors only.
- **Please refer to instructions of plumbing constructors.**
- Please pay attention to the warnings in this manual and ensure that it is read before the installation-start up process. **MAS DAF MAKINA SANAYI A.Ş.** is not responsible for the accidents resulting from negligence.
- If you cannot find an answer to your questions in this

manual, it is suggested that you contact **MAS DAF MAKINA SANAYI A.Ş.** Please inform us about the rated value and especially the serial number of the pump when you get in contact for help.

- The safety instructions in this manual cover the current national accident protection regulations. Beside all of these, an operation, work and safety measure imposed by the costumer has to be applied.

The Signs Used in This Operation Manual



Read the instructions carefully in this operating manual and keep it for your future reference.



Warning sign against the electrical risks



Sign for the operator's safety

1. IMPORTANT SAFETY PRECAUTIONS

In order to minimize the accidents during the mounting and putting into service of the pump, the following rules have to be applied:

1. Do not work without taking safety measures relevant to equipment. Cable, mask and safety band must be used when necessary.
2. Be sure there is adequate amount of oxygen and there is no toxic gaseous around
3. Before using welding or any electrical equipment make sure that there is no risk of explosion.
4. Check the cleanliness of the area to take care of your help. (Dust, smoke, etc.)
5. Do keep in mind that there is a risk of having accidents related to electricity
6. Do not lift the pump before you check the transport equipment.
7. Be sure you have a by-pass line
8. Use helmet, eye glasses and protective shoes for your safety
9. Place a protective barrier around the pump within the necessary safety area
10. Dust, liquids and gaseous that may cause overheating, short circuit, corrosion and fire must be kept away from the pump unit.
11. By checking the noise level of the pump unit, necessary measures to avoid noisy operation of the pump that can have harmful effects on the personnel and environment.
12. Be careful about the direction of transport and storage.
13. Cover appropriately the moving parts to avoid possible injury of the personnel. Mount the coupling guard and belting before starting-up the pump
14. All the electrical and electronic applications must be performed by authorized person conforming EN60204-1 and /or domestic instructions.

15. Protect the electrical equipment and motor against overloading

16. If flammable and explosive liquids are pumped, ground connection of electricity should be carried out properly

17. Do not expose the pump unit to sudden temperature variations

18. All personnel who work with the waste water system need to be vaccinated in case of contagious diseases.

19. If the pump contains hazardous liquids, one must use protective helmet against the risk of splatter. One also must accumulate the liquid in a proper container against any risk of leakage.

All Other Health and Safety Rules, Laws and Regulations Must Be Applied

2. GENERAL

2.1. Definition of Pump and Usage Areas

NM series pumps are single stage, end suction volute type pumps. They are used in:

- Water networks and pressurization facilities
- Irrigation, sprinkling and drainage systems
- Hot and Cold water circulation in heating and cooling systems.
- Condense water pumping
- Water circulations in pools Read the instructions carefully in this operating
- Health purification facilities manual and keep it for your future reference.
- Industrial and social facilities
- Fresh and sea water pumping in ships.

They shall be used to pressurize liquids (up to 130°C) which are clean or mildly impure, non abrasive, and not containing large solid particles or fiber.

CAUTION

Please contact MAS DAF MAKINA SANAYI A.Ş. for liquids that have different chemical and physical specifications.

We have extended NM type centrifugal pumps with 22 additional types, as well as 25 types which conform to EN 733 standards. Totally, we have 47 types in our productions.

Technical specifications of NM type pumps

Suction Flange : DN 50-DN 400
Discharge Flange : DN 32-DN 350
Operating Pressure : 10 bar.

Operating Temperature : -25 – 130°C
Impeller Diameter : Ø160-Ø500

Capacity : 5-3500 m³/h
Hm : 4-105 m.
Speed : 1000-3600 rpm

Product Information as per Regulation No. 547/2012 (for Water Pumps with a Maximum Shaft Power of 150 kW) Implementing "Ecodesign" Directive 2009/125/EC

Minimum Efficiency Index for MAS NM Pump Series is shown on the pump label.

MEI values of MAS NM Pump Series are shown on the pump characteristic curves.

Minimum Efficiency Index for MAS NM Pump Series; Minimum 0.4. (MEI≥0,4)

Efficiency values of the pump characteristic curves, which are cut diameter, are expressed in %.

NM Series water pumps, the pump efficiency can be achieved more than fix speed in case of variable speed control.

More information about the Ecodesign can be reached at www.europump.org

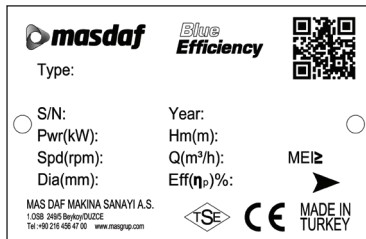

Figure 1: Pump Label

2.2. Performance Information

Actual performance of the pump can be obtained from the order page and/or from the test report. This information is given on the pump label. The performance curves given in the catalog are valid for water whose density and viscosity are $\rho=1 \text{ kg/dm}^3$ and $\nu=1 \text{ cst}$, respectively. For those liquids whose densities and viscosities are different from those of water, please consult with **MAS DAF MAKINA SANAYI A.Ş.** since the performance curves vary with density and viscosity.

CAUTION

Do not operate the pump with a motor that has a different power except for the given catalog and label values.

The pump is not to be operated at off-design point given in the order and supplied from the firm. It is necessary to ensure that the instructions are obeyed for the safe running of the pump.

2.3. Warranty Conditions

The entire products in our selling program are warranted by **MAS DAF MAKINA SANAYI A.Ş.**

The warranty conditions will only be valid when all the instructions about installation and start-up operations of the pump unit are taken into account.

2.4. Test

All Pumps are dispatched for sale when all the performance and pressure tests are completed. Proper assurance of material and fault-free operation of pumps whose performance tests are made is under the warranty of **MAS DAF MAKINA SANAYI A.Ş.**

2.5. Pressure Limit



Pressure at the discharge flange must not exceed 10 Bar. A special order is necessary for applications with higher pressures.

3. SAFE OPERATING CONDITIONS

This manual contains main safety instructions for the installation, operation and maintenance. It must be read by the personnel who are responsible for installation and operation. This manual should always be kept near the installation location. It is important to comply with safety precautions stated in page 1 along with the general safety instructions as well as preventive measures repeated in other sections of this manual.

3.1. Training of Personnel

Installation, operation and maintenance personnel must have necessary knowledge in order to accomplish the given job. The responsibility, adequacies and controlling duties of such personnel must be determined by the customer. It has to be certain that these personnel comprehend totally the content of the operating manual.

If the personnel do not have enough knowledge, required training must be given by the customer. If training support is needed by the customer, it will be provided by the manufacturer/seller.

CAUTION

Untrained personnel and unwillingness to comply with safety instructions may be risky for both machine and environment. **MAS DAF MAKINA SANAYI A.Ş.** is not responsible for this kind of damages.

3.2. Hazardous Conditions That May Occur When One does not Comply With the Safety Instructions

Incompliance with safety regulations may put the personnel, the environment and the machine in danger and thus may cause damages. Incompliance with safety regulations may give rise to situations listed below.

Important operational functions of the factory may stop.

Maintenance may get difficult.

One may get injured by electrical, mechanical or chemical hazards.

3.3. Safety Measures for Operator

Dangerous, hot or cold components in the pump area must be covered so that one cannot touch them. Moving components of the pump (such as coupling) must be covered so that one cannot touch them. Those covers must not be dismantled while the pump is running. Dangers that results from electrical connections must be removed. To get more information about this subject, you can refer to domestic electrical instructions.

3.4. Safety Measures for Maintenance and Installation

The customer must assure that all maintenance, check and installment tasks are performed by qualified personnel. Repair work must only be performed while the machine is not running.

The pump and its auxiliary system must be cleaned thoroughly if it contains hazardous liquids. At the end of the repair work, all safety and protective equipment must be re-installed.

3.5. Spare Parts Replacement

Replacement of spare parts and all modifications must be done after contacting with the manufacturer. Spare parts and accessories certified by the manufacturer are important for the safe operation of the system.

Notice: **MAS DAF MAKINA SANAYI A.Ş.** is not responsible from the usage of improper spare parts.

4. TECHNICAL INFORMATION

4.1. Design

These are single stage, single suction with a horizontal opening and a vertical discharge opening volute type (with horizontal shaft) pumps. They have closed radial impellers in accordance to DIN 24255 and EN 733 standards.

4.1.1. Volute Casing

The axis of suction opening is horizontal while the axis

of discharge opening is vertical and the pumps have volute type casings. Suction and discharge flanges are in accordance to DIN 2533 standard.

4.1.2. Locations of Flange – Flanges

Suction Flanges:	In axial direction	DN50-DN400
Discharge Flange:	Radially upward	DN32-DN350
Discharge Flange:		DIN 2533-PN 16
Suction Flanges:	50-200	DIN 2533-PN 16
	250-400	DIN 2532-PN 10

4.1.3. Auxiliary Fittings

Please refer to the technical drawing of the pump for necessary auxiliary fittings.

4.1.4. Impeller

The impellers of NM type pumps are (full) radial, double-sloped (Francis type) or mixed flow types. The impellers are balanced dynamically in an electronic balance machine. The thrust (axial force) is balanced with the back wear ring and balance holes.

4.1.5. Shaft

The pumps are provided with the rigid shaft capable of supporting different loading conditions. Since the shaft diameter is highly resistant to bending and the distance between the bearing and the sealing is short, pump can operate at optimal conditions for the sealing.

4.1.6. Bearing and Lubrication

Rolling bearings are used in norm centrifugal pumps. In pumps complying with DIN 24255, the bearing is provided with two 6300-2R5-C3 type ball bearings which are lubricated lifelong with special grease according to DIN 625 standard. For larger pumps, one 3300 type and one 6300 or NU 300 type rolling bearing are used. In order to prevent the leakage flow into the bearing housing, deflectors are provided in front of the bearing covers.

4.1.7. Seals

In standard production, teflon-knit non-cooled soft packing is used for sealing. (It is suitable up to 90°C). There is a lantern ring in the stuffing box.

- Application of non-cooled mechanical seal is optional (up to 90 °C)
- It is optional to use packing or mechanical seals with cooling sleeves

Figure 20-a: Design with packing

Figure 20-b: Design with cooling sleeve

Figure 20-c: Design with mechanical seal. (Bellows type)

Figure 20-d: Design with mechanical seal. (Spring actuated type)

4.2. Construction of Pump Group

4.2.1. Drive

TEFC (Totally Enclosed Fan Cooled) 3 phase, squirrel caged, in accordance to DIN 42673, IM 1001B3 type electrical motor which complies with DIN IEC and VDE is used to drive the pump in proper speed and power.

Specifications of electrical motor;

Isolation class	: F
Protection class	: IP 54-IP 55
Frequency	: 50 Hz
Running type	: S1
Start up type	: Up to 4 kW, 3x380V (Y) More than 4 kW, 3x380V (Δ)+(Y/Δ)

4.2.2. Coupling and Coupling Guard

At NM type pumps, a flexible coupling is used. A coupling guard is given in accordance with EN 953.



Pump can only be run with a coupling guard in accordance with EN 953 according to safety instructions.

If there is no coupling cover, it is provided by the operator.

4.2.3. Base Plate

It is manufactured from U profile steel in accordance with DIN 24259.

5. TRANSPORT AND STORAGE

Suction, discharge and all auxiliary fittings must be closed during transport and storage. Dead-end covers must be removed while the pump unit is being installed.

5.1. Transport

Pump and pump group must be carried safely to the installation location by lifting equipments.

CAUTION

Current general lifting safety instructions must be applied. Please use a suspension system shown in figure while you are carrying and lifting the pump unit. The suspension rings may be broken because of the excessive load and may result in adamage of the pump. Prefer fabric cable for suspension.

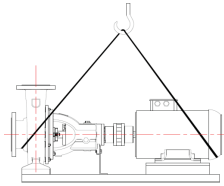

Figure 2: Transport of Pump Group



Incorrect lifting may damage the pump unit and cause injuries.

Damages caused in transport

Check the pump when it is delivered to you. Please let us know of there is any damage.

5.2. Storage



Please keep the unit clean and dry area during storage.

If the pump is out of use for a long time, please consider the instructions below.

1. If there is water inside the pump, drain it.
2. Clean the pump casing and impeller by jetting clean water for a short time.
3. Empty water inside the pump casing, suction line and discharge line.
4. Add small amount of antifreeze inside the pump casing if it is not possible to empty it completely. Rotate the pump shaft by hand to mix the antifreeze.
5. Close the suction and discharge exits with gasket
6. Spray an anti-corrosive into the pump casing.
7. Rotate the pump shaft by hand once in every month, in order to protect it from freezing and to lubricate the bearings.

6. ASSEMBLY / INSTALLATION

6.1. Installation

In our standard production, the pump and the motor have been installed in a common base plate.

6.1.1. Location of Installation

Pump shall be installed in a location where the control and the maintenance of the pump are easily made. The pump room shall be suitable for operation of lifting systems such as freight elevator, forklift, etc.

The pump group should be installed in the lowest

possible location of the pumping system in order to achieve the highest suction pressure.

6.1.2. Location of Installation- Local Ambient Temperature

When the local ambient room temperature exceeds +40°C in a pumping system, suitable ventilation should be provided in order to remove the heat dissipated to the environment and supply fresh air.

6.2. Type of Connection

Type of connection depends on the design type and the size of the pump and the motor, as well as the local installation conditions. Foot-mounted horizontal pump-motor units have been installed in a common base plate.

6.3. Foundation

6.3.1. General

Base plate of the pump must be grouted. The foundation shall be of concrete or steel framework.

NOTICE: The foundation shall distribute the weight of the pumping group evenly.

6.3.2. Main Properties of the Steel Framework Bases

Foundations with steel framework shall be designed in such a way that the base plate is bolted or welded contacting to all area.

CAUTION

If base plate is supported from only four points, pump group will stay in the middle, causing misalignment of the coupling and increasing the noise level.

6.3.3. Foundation Properties

The foundation shall be horizontal, flat and clean and shall support all the weight.

NOTICE: Reinforced concrete bases are constructed from standard concrete with at least B 25 resistance class.

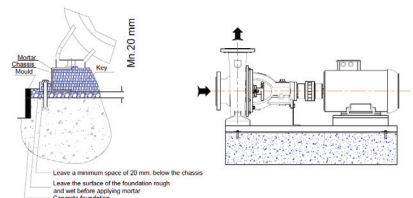

Figure 3: A Typical Concrete Foundation

6.3.4. Fixing (Securing) of Pump Group

After the alignment of the pump group on the foundation has been made, the mutual securing bolt screws should be used alternately to fix the pump group. All of the area of the base plate should be filled with gout as much as possible.

NOTICE: While securing pump group with the mortar bonding agents and molding, one has to make sure that the base plate contacts completely with the base with no cavities between the surfaces. Inside of the chassis (frame) should be completely filled with concrete

6.4. Coupling Alignment

6.4.1. General

For a proper operation of a pump group, a good alignment of the coupling is necessary. Vibration, noise, overheating of the bearings, overcharge problems can be attributed to the misalignment of coupling or using an improper coupling.

Flexible coupling does not correct the axial misalignments between the pump and the motor axes. However, it allows pinpointing the misalignments.



In order to avoid overheating, vibration, noise and wearing of the rolling bearings, alignment of the coupling has to be made properly and checked often.

Do not use a different coupling other than the original type installed on pumping group.

6.4.2. Method of Coupling Alignment

In order to make the alignment of the coupling, it is required to have at least two pieces of about 10 cm tall, smooth-edged metal parts (e.g. a steel ruler or a gauge stick) and one precision calipers. (Figure 5)(For more precision alignments, special apparatus can be used). Coupling misalignments in general are of two kinds:

1. Paralel Axis Misalignment (Figure 6-Figure 8)

In order to control parallel axis misalignment, a smooth edged gauge stick is pressed axially over the upper half of the coupling. Then, the gauge stick is checked for the other half of the coupling. For alignment, the gauge stick shall be in contact with both of the halves at the same time. This procedure shall be repeated for four sides of the coupling. (i.e. top, bottom, left and right sides of the coupling). When all four sides give reasonably accepted results, alignment of the coupling has been ensured.

2. Angular Misalignment (Figure 7-Figure 9)

In order to control the angular misalignment, the distance between the two halves of the coupling is

measured in both horizontal and vertical planes. Measurements taken at four points shall be in agreement for the alignment.

Misalignments can be in horizontal or vertical planes. Misalignments in horizontal plane can be fixed by placing sheet iron at the bottom of the pump or motor base, while misalignments in vertical plane can be fixed by sliding the pump or the motor in horizontal plane.

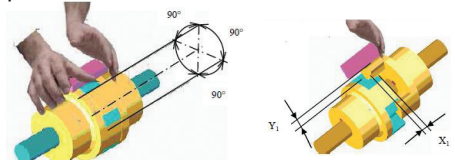

Figure 4: The Control of the Coupling Alignment in Horizontal and Vertical Planes

Figures below illustrate the possible coupling misalignments and the methods to correct them.

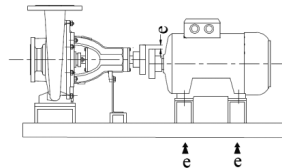

Figure 5: Paralel Axis Misalignment in Vertical Plane and Its Correction

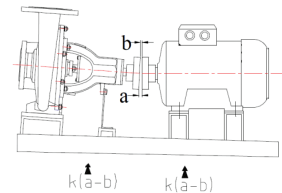

Figure 6: Angular Misalignment in Vertical Plane and Its Correction

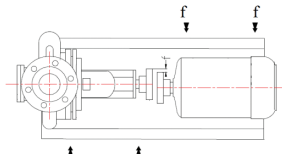

Figure 7: Parallel Axis Misalignment in Horizontal Plane and Its Correction

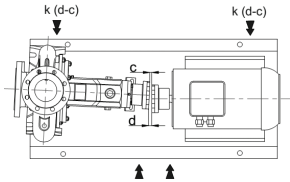

Figure 8: Angular Misalignment in Horizontal Plane and Its Correction



Install the coupling guard only when the alignment of the coupling is checked.

6.4.3. Pump and Motor Mounting (Coupling)

If the coupling of the pump group is to be mounted on site, the following procedure should be followed.

1. Coat the shaft tip of the pump and the motor sides with a sheet of molybdenum disulfide.
2. Push the coupling halves with a driving apparatus towards the pump and the motor shafts, until the shaft is fit to snag to the hub of the coupling. If a driving apparatus is not available, heating coupling halves (with coupling rubbers off) to an approximately 100 °C may help the pushing. It is important that axial force is prevented from occurring while mounting the coupling. Support pump shaft from the impeller side, and motor shaft from the fan side while mounting the coupling. If necessary, dismantle the fan cover.
3. Screw the two bolts in coupling hub.
4. Make sure that a suitable spacing is left between the coupling halves while mounting pump and the rotor.
5. Horizontal pump groups mounted on the base plate or directly mounted on the base, alignment of the coupling shall be as described in 6.4.2.
6. Put into place the coupling guard.



According to the accident prevention regulations, all preventions and protective devices should be in their intended place and in operational form.

6.5. Piping

6.5.1. General



- Do not use the pump as the hinged support for the piping system.
- Put enough supports under the piping system in order to carry the weight of the pipe and fittings.
- Avoid piping system loads on pump by installing flexible components (compensator) to suction and discharge of the pump.
- By mounting flexible supporting items, take into

consideration the fact that these items may elongate under the pressure.

- Suction pipe shall be in a constantly increasing slope to the pump. Air in the suction pipe shall be arranged to move into the pump
- Discharge piping shall be in a constantly increasing slope to the reservoir or discharge point, without up and downs which can cause air pockets in the piping system. At locations where forming of air pockets is possible, special items like air valve and air cock are mounted to evacuate the trapped air.
- It is important that pipe diameter and fittings are at least as much as the pump opening diameter or preferable one or two size higher. One should never use fittings with smaller diameters than the pump exit diameter. In particular, preferred fittings like foot valve, strainer, filter, check valves and valves shall have large free passing area, and low friction loss coefficient.
- For piping systems with hot liquids, thermal expansions are to be taken into account and compensators shall be mounted in accordance with these expansions. Caution shall be exercised to avoid the loading of pump in this installation.

6.5.2. Specification of Work in Piping Installation



In installation of pipes, follow the procedures below certainly.

- Install the pump on the concrete base as illustrated in Figure 3.
- Take out the guards (placed by the manufacturer) from suction and discharge openings of the pump.
- Close the suction and discharge flanges with rubber gaskets. This precaution is important to avoid the undesired substances (weld crust, weld slag, sand, stone, wood piece etc.) get into the pump. Do not take off this gasket until the installation is completed.
- Start the installation of piping from the pump side. Do the necessary assembling and welding of the parts in a successive order.
- In these operations, do not neglect to put the necessary supports in their respected locations.
- Following above procedure, complete all piping system at suction side up to the suction tank (or foot valve if available), at discharge side up to do discharge collector and discharge pipe.
- When all installation and welding process is done and the heat dissipated by welding is removed, dismantle all the bolted connections from the suction tank to discharge pipe. Take out all demountable parts.
- Clean these parts and then paint body coat completely inside and outside.
- Mount the parts again in their intended places. However, this time start from the discharge line and move downward to the pump. In this instance, do not forget to check the flange gaskets. If needed, (for example deformation during welding) replace them.

- Concerning the connection of the pump flanges to piping, in case of misalignment of axis and flange holes, do not force the system to eliminate the misalignment. Forcing the system may cause difficult-to-correct problems.
- If there is an axial misalignment between the flanges of the pump and the pipe, due to the welding or any other reasons, cut the pipe from a suitable location in order to fix the problem. Connect the pipe (pump side) to the pump. After carrying out the necessary correction, connect the parts again by welding.
- Dismantle and clean the last welded part. Repaint again and mount on its place.
- After all these processes are accomplished, remove the rubber gasket from the suction and discharge openings. Open their holes and mount them again on their intended place.

6.5.3. Specification of Work after Installation of Piping and Piping System

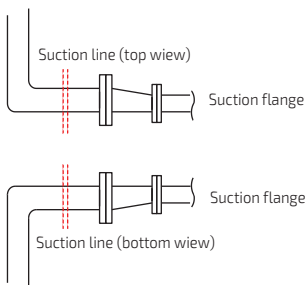

Figure 9: Piping System

An illustrative piping system is shown in Figure 20. Appropriate manometers shall be mounted on suction and discharge pipe lines.



Complete the auxiliary pipe connections in piping system if exist (cooling to bearing housing, and stuffing box (seal), relief pipe, oil pipe etc.)

6.6. Motor Connection

Motor shall be connected by an electrical technician according to the connection (switch) diagram. Local electricity policies regulations have to be applied.



- Electrical connections have to be made by authorized electricians.

- In dismantling the pump, make sure the electricity is cut off before taking the motor cover out.
- Use the appropriate electrical connection to the motor.



Never operate pump units not connected electrical cable connections correctly.

6.6.1. Motor Connection Diagram

Motors requiring high moments at start up shall not be connected star- delta
Frequency controlled motors, require high moment at start up and have to be cooled properly at low speeds. Provide the necessary cooling for the motors.

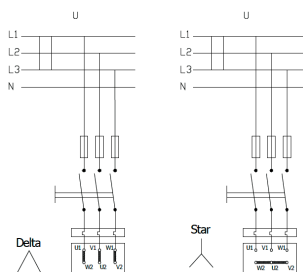

Figure 10: Electric Connection Diagram

Electrical circuit	Motor	
U (Volt)	230/400 V	400 V
3 x 230 V	Delta	
3 x 400 V	Star	Delta

6.6.2. Motor Protection

- Three phased-motor shall be connected to power supply.
- Wait the motor to cool down when thermic protected motor breaks in circuit due to the overheating. Make sure the motor does not start automatically until it cools completely
- In order to protect the motor from overcharging and short circuit use a thermic or thermic-magnetic relay. Adjust this relay to the nominal current of the motor.



Electrical equipments, terminals and the components of the control systems may carry electric current even though they are not operating. They may cause deadly and serious injuries or irreparable material damages.

7. COMMISSIONING, START UP AND OPERATING

7.1. Preparations Before Start Up

OIL CHECK: NM type pumps are provided with self-greased rolling bearings requiring no servicing in life long. Therefore, it is not necessary to check the oil.

- Check pump seals
- Make sure that the pump and the suction pipe is completely filled with water before the starting. If the pump operates on a positive suction head, no problem will be encountered. Suction valve is opened and air drains are un-tightened.
- Pumps with foot valve are filled with water by opening the pump filling tap or, one takes advantage of the water accumulated in the discharge pipe and by using a small valve the check valve is bypassed and the pump is filled.
- In vacuum pump driven pumps, by operating the vacuum pump one achieves to fill the pump via increasing the water level in the suction pipe.

CAUTION

Do not start your pump dry (WITHOUT WATER).

7.2. Checking The Direction of Rotation

CAUTION

- The direction of rotation is indicated on the pump label with an arrow. Apart from special cases, it is clockwise direction when looking from the motor end. Observe if the pump is rotating in the expected sense by starting the motor for a very short instant. If it is turning in the opposite sense, interchange any of two motor leads.
- If the motor connection is delta, open the discharge valve slowly.
- If the motor connection is star-delta, set the time relay to maximum 5 seconds. Monitor the passage from star to delta by pressing the start button. As soon as you are assured that the connection is delta, open the discharge valve slowly. Continue opening the valve until you read the amperage on the electrical panel.
- **One should always check the labels which show the direction of rotation and the direction of fluid flow. If you dismount the coupling protection to monitor the direction of rotation, do not restart the engine before remounting the protection.**



As a result of getting in touch with rotating and stable parts each other temperature increase can occur. Never check the direction of rotation while the pump is dry.

7.3. Start up Procedure

- Check if the suction valve is open and the discharge valve is closed. Start the motor
- Wait until the motor reaches sufficient speed. (In Star-delta connections, wait until the engine passes to delta connection.)
- Keeping an eye on the amperage shown on the panel, open the discharge valve slowly.
- In the primary operation, if the discharge pipe is empty, do not open the valve completely. By keeping an eye on the amperage, open the valve with care regarding that it should not exceed the value indicated on pump's label.
- After opening the valve completely, check the pressure from the pump exit manometer and make sure that this value is the pump operating pressure value and is indicated on pump's label.
- If the value one reads is less than the pump label value when the valve is completely open, it means that the height is miscalculated. Increase the value by narrowing the valve and bring it to pump's label value.
- If the value one reads is greater than the pump label value when the valve is completely open, it means that the height is calculated less than what it should be in reality. The device is pumping less than what is requested. Check the installation and the calculations.
- **Minimum flow rate:** If the pump is working with zero flow rates (closed valve) from time to time during its operation, the water inside the pump may endanger the pump by getting warmed up. In such cases, a minimum flow valve must be connected to the pump exit.

CAUTION

Stop the motor if the pump gets too hot. Wait until it gets cold. Then start the system up again carefully.

7.4. Shut Down Procedure

CAUTION

During sudden start ups and stops, a pressure reducing valve must be placed at the exit section of high flow rate pumps whose discharge pipelines are long, in order to reduce water hammer effect. Water hammer may explode the pump.

In normal conditions (apart from sudden power shut down, etc), stop the pump as below:

- Close the discharge valve slowly
- Switch the power off, stop the motor. Notice that the rotor slows down.
- Do not start up the motor at least before 1 to 2 minutes.
- If the pump will be out of use for a long time, close the suction valve and auxiliary circuits. If the pump is outside and if there exists a danger of frost, remove all drain taps and empty all the water inside the pump. (5.2. Storage)

CAUTION

If the pump is outside and if there exists a danger of frost, remove all drain taps and empty all the water inside the pump.

8. MAINTENANCE

Maintenance operations must be done by authorized personnel with protective clothing only. The personnel must also beware of high temperatures and harmful and/or caustic liquids. Make sure that the personnel read carefully the manual.

- The instructions in Safety Precautions must be executed during maintenance and repair
- Continuous monitoring and maintenance will increase the engine's and pump's lives.

The instructions below should be applied.

8.1. The Checks During the Operation

- Pump must never be operated without water.
- Pump must not be operated for a long time with the discharge valve closed (zero capacity).
- Precautions must be taken against flare up when the component temperatures are over 60°C. "Hot Surface" warnings must be placed over necessary areas.
- All the auxiliary systems must be in use while the pump is operating.
- If the pump has mechanical sealing, there is no need for excessive maintenance. Water leakage from the mechanical sealing indicates the fact that the sealing is worn out and therefore needs to be replaced.
- If the system consists of a substitute pump, keep it ready by operating it once a week. Check also the auxiliary systems of the substitute pump.



Occuring explosive ambient inside of the pump must be prevent. The air of the pump and suction line must be drained before commissioning of the pump. The interior of the pump contacting with pumped liquid including gasket way and auxiliary systems must be filled with pumped liquid.

- Ensure that delivery pressure is enough.
- Exceeded the allowable using limits regarding pressure, temperature, transporting material and

motor speed may cause explosion risk, hot and poison liquid may leak to external environment.

- Do not operate the pump at values above pressure, temperature or motor speed values specified by manufacturer, never use improper liquids with the pump.

8.1.1. Component Check

CAUTION

To make possible the visual control, one must be able to reach the pump from any direction. Especially, to be able to dismount the internal units of the pump and the engine, sufficient free space must be created around them for maintenance and repair. Furthermore, one must make sure that the piping system can easily be dismounted.

8.1.2. Bearing and Lubrication

NM type pumps are provided with two (life long) carefree rolling bearings in accordance to DIN 625. The usual service life of the rolling bearings attains at least the operating hours indicated in the technical specifications of DIN ISO 5199.

8.1.3. Shaft Seal Maintenance

8.1.3.1. Packing

- Before replacing the soft packing, the gland must be dismounted first. Used packing rings may be taken off by a sharp pointed tool. Take off the lantern ring if it exists, then clean the interiors of the sealing box, the gland and the lantern ring.
- Wrap a proper sized, good quality sealing over the shaft bush and make sure that the bush tip is completely covered.
- Place the first ring, its joint facing upwards and push it to its bed by using the gland
- If it exists push the watering ring to its bed.
- Place also the other rings to their beds alternating, i.e., their joints facing upwards and downwards.
- After placing the last ring, position the gland and tighten it completely. Thus, the squeezed sealing rings take the shape of the sealing box.
- Then un-tighten the nuts. Rotating the shaft tighten them slowly again. When you feel that the shaft is put on a brake, stop the tightening.
- Water must come from the seals drop by drop as soon as the pump is started. The number of drops must not be less than 10 and not more than 30 per minute. Find the proper setting by tightening and un- tightening the opposite gland nuts.



- Ensure that the water leaking from the sealing is collected and/or discharged in a manner which is appropriate in terms of safety and environmental criteria.

- Check the sealing temperature two hours after the gland adjustment is made. For a system which pumps water at ambient temperature, the sealing temperature must not exceed 80°C.



Cooling seal arrangements are provided for pumps working with high temperature liquids.

CAUTION

When tightening the gland nuts do not work with long sleeve shirts. Otherwise it is possible to get caught by the turning shaft and get injured.

8.1.3.2. Mechanical Seal

Mechanical Seals are absolutely leak tight and needs less maintenance than soft packing.

Mechanical seal;

- 1. Provides leak proof operation in heavy operating conditions (in waste water pumps, chemical process and refinery pumps).**
- 2. Easily mountable and needs less maintenance.**
- 3. Does not cause wearing on the shaft**
- 4. Sealing operation does not depend on the quality of shaft finishing.**

8.1.4. Coupling

As mentioned in Section 6.4, coupling adjustment must be checked regularly.



Worn out elastic bands must be replaced.

8.1.5. Drive

Apply to the operating instructions of the motor manufacturer.

8.1.6. Auxiliary Components

Check regularly the fittings and the gaskets, replace the worn out pieces.

8.2. Service

Our Customer Service Department offers after-sale service. Manager should employ authorized and trained personnel for mounting/dismounting procedures. Before these procedures, one must make sure that pump interior is clean and empty.

This criterion is also valid for the pumps which are sent to our factory or to our service points.



Maintain the safety of the personnel and the environment in every field procedure.

8.3. Spare Parts

The spare parts of NM type pumps are guaranteed for 10 years by **MAS DAF MAKINA SANAYI A.Ş.**

In your spare parts requests, please indicate the below listed values that are indicated on your pump's label.

Pump type and size:
Motor power and speed:
Pump serial number:
Capacity and head:

If you wish to keep spare parts in store, depending on the number of same type of pumps, for two operation years, the quantities which are listed in the table below are recommended.

Component Name	The Number of Equivalent Pumps in the Installation						
	1-2	3	4	5	6-7	8-9	10+
Shaft (Wedge included) (quantity)	1	1	2	2	2	3	%30
Impeller (quantity)	1	1	1	2	2	3	%30
Ball bearing (kit)	1	1	2	2	3	4	%50
O-Ring for casting (kit+1)	1	1	1	2	2	3	%40
O-Ring for shaft (if exist) (kit)	1	1	2	2	3	4	%50
Soft packing (kit)	2	2	2	3	3	4	%50
Sealing bush(if exist)	1	1	1	2	2	3	%30
Coupling rubber sleeves (kit)	1	2	2	3	3	4	%50

Table 1: Spare PartList

9. NOISE LEVEL AND VIBRATION

The reasons which increase the noise level are indicated below:

- Touch of coupling halves due to worn rubber sleeves (incorrectly aligned)
- Noise level increases due to the fact that the pump is not founded properly (Vibration)
- If the installation does not have compensator noise and vibration increases.
- Wearing in ball bearing also increases noise level.



Check if there is any noise increasing elements in your installation.

9.1. Expected Noise Values

Measurement conditions:

- The distance between the measure point : 1m
- Operation : Without Cavitation
- Motor : IEC Standard Motor
- Tolerance : ± 3 dB

Power of Motor PN [kW]	Sound Pressure Level [dB] *	
	Pumpwith Motor	
	1450 rpm/min	2900 rpm/min
<0,55	63	64
0,75	63	67
1,1	65	67
1,5	66	70
2,2	68	71
3	70	74
4	71	75
5,5	72	83
7,5	73	83
11	74	84
15	75	85
18,5	76	85
22	77	85
30	80	93
37	80	93
45	80	93
55	82	95
75	83	95
90	85	95

Table 2: Sound Pressure Level

(*) Without protective sound hood, measured at a distance of 1 m directly above the driven pump, in a freespace above a sound reflecting surface.

The above values are maximum values. The surface noise pressure level at dB(A) unit is shown as (L_{pA}). This complies with TS EN ISO 20361.

10. DISASSEMBLY, REPAIRAND REASSEMBLY



Before starting work on the pump set, make sure it is disconnected from the mains and can not be switched on accidentally.

Follow the safety precautions outlined in "Safety instructions".

10.1. Disassembly

- Close all valves in the suction and discharge lines, drain the pump by the drain plug (260).
- Drain oil from the bearing housing (30) if the pump is oil lubricated.
- Remove coupling guard and other safety guards.
- If a Spacer Type Coupling is used between the pump and the motor, there is no need to disconnect the motor from the Baseplate. To take out the Spacer Part is enough.

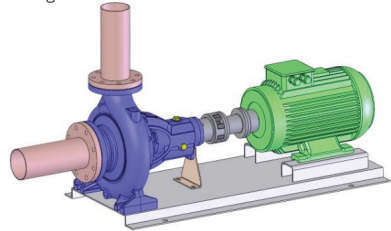

Figure 11- Disassembly - 1

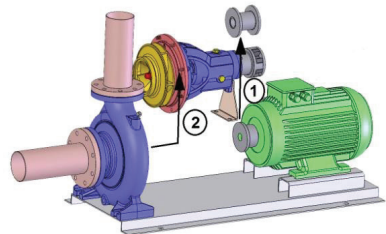

Figure 12- Disassembly - 2

- Thanks to "Back Pull Out Design"; the impeller, shaft and other rotating parts being removable no need to disconnect the suction and delivery pipes.
- If to take out the complete pump is necessary, disconnect pump from the driver, suction and discharge pipes and detach the baseplate.

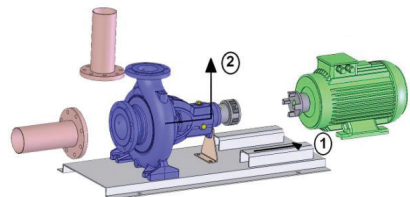

Figure 13: Disassembly - 3

- Disconnect the casing nuts (360) and take out the pump rotor assembly (Impeller + Shaft + BearingHousing + Bearings + Bearing Covers + Stuffing-box etc.)
- Take out the pump coupling half from the shaft (60) using a pull-off device and remove the coupling key (211).
- Unscrew the impeller end nut (65) and take out the impeller (20) and impeller key (210). Use rust remover solvent during dismantling if necessary.
- Unscrew the nuts (360) bearing housing to the stuffing box.

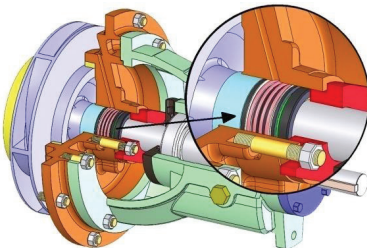

Figure 14: Disassembly - 4

- If there is the mechanical seal, unscrew the seal cover (55). Separate the stuffing box from the bearings. Mechanical seal will remain on the shaft.

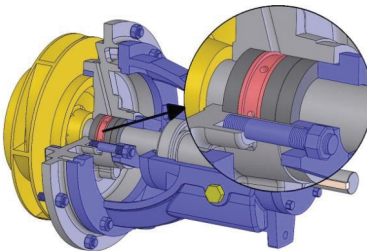

Figure 15: Disassembly - 5

- For pumps with soft packing, you can pull out stuffing box directly.
- Dismantle the bearing covers (35)
- Dismantle bearing by using a pull-off device. Do not use metal hammer for this operation.

10.2. Reassembly

- Reassembly proceeds in reverse sequence to disassembly as described in section 10.1. You may find the attached drawings useful.
- Coat the seats and screw connections with graphite,

silicon or similar slippery substance before reassembly. If you can not find any of the above you may use oil instead (except the pumps for drinking water).

- Never use the old gaskets, make sure the new gaskets and o-rings are the same size as the old ones.
- Start mounting from the bearings. Place ball bearings on their places on the shaft by slightly heating or by using press.
- Wait until bearings get cool. (Cool if it is possible). Put this part to the bearing housing from the coupling side. (With pressor plastic hammer)
- Reassembly the bearing cover on its place.
- On pumps with mechanical seal is used; put the stationary part of mechanical seal in its place on the seal cover (58-59). Then put this part on the shaft. Afterwards put the rotating part of mechanical seal on its position.
- On pumps with packing is used; put the stuffing box gland in position. And fixed the gland nuts gently.
- Mount stuffing box (03) to bearing housing (30).
- At this stage you can insert the stuffing box and irrigation ring.
- Replace impeller key and pump impellers. Tighten the impeller nuts.
- Replace the coupling and coupling key.
- On pumps with mechanical seal is used, tighten mechanical seal cover; on pumps with packing is used, tighten the gland nut.
- Now reassembly of the rotor group is completed.
- Finally mount rotor assembly to the volute casing. (In the repair shop or on site.)
- Make sure the gaskets and o-rings are evenly placed without sliding and not damaged or not squeezed at all.
- Place the pump on the base plate, couple the motor. Connect suction and discharge pipes as well as auxiliary pipes. Take the unit into operation as it was indicated in section 7.



Check whether the faces contacting with another faces are damaged for avoiding explosion before reassembling of the motor. The parts having deformed faces must be replaced. Ensure that the rotating parts are fitted with the guards.

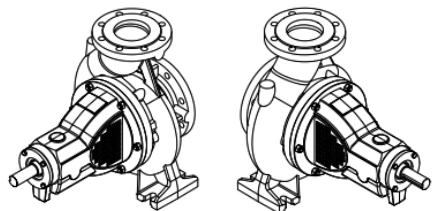

10.3. Coupling Guard Assembly

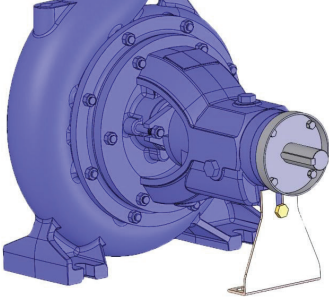

Figure 16: Coupling Guard Assembly - 1

Mount (1) numbered part to bearings mounted on the pump.

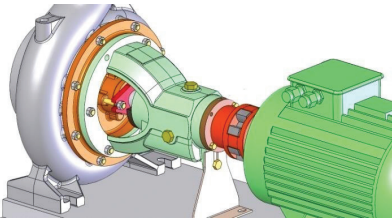

Figure 17: Coupling Guard Assembly - 2

Connect motor and pump with coupling.

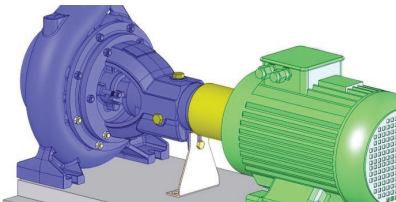

Figure 18: Coupling Guard Assembly - 3

Place the coupling guard.

11. POSSIBLE FAILURES, CAUSES, SOLUTIONS

Possible failures and solution strategies are listed in the table below. Please apply to the Customers' Service Department of our company when a generic solution is not found to your problem.



While the failures are repaired the pump must always be dry and un-pressurized.

POSSIBLE FAILURE	CAUSES	SOLUTIONS
The pump delivers insufficient capacity	<ul style="list-style-type: none"> Discharge head too high Very high counter pressure Pump and/or pipe cannot discharge air, cannot suck Occurrence of air pockets inside the pipe NPSH is too low 	<ul style="list-style-type: none"> Readjust the operating point See if there is any undesired material inside the pipe Vent completely the pump and the pipe Change the piping configuration Increase the liquid level
Motor overload	<ul style="list-style-type: none"> System pressure is lower than the requested pressure level Speed too high Liquid pumped of different specific gravity and viscosity than that for which pump is rated Engine works at two phases 	<ul style="list-style-type: none"> Adjust the operating pressure to the label value Decrease the speed Increase the engine power Replace the fuse and control the electrical connections
Pump head is too high	<ul style="list-style-type: none"> System pressure is higher than the requested pressure level 	<ul style="list-style-type: none"> Set the operating pressure to the label value
Bearing temperatures are high	<ul style="list-style-type: none"> Worn out coupling Too much, too little or improper lubrication Increase in axial forcing 	<ul style="list-style-type: none"> Replace the coupling Change the oil, decrease or increase its quantity Clean the balance holes on the impeller disc
Excessive leakage from the stuffing box	<ul style="list-style-type: none"> Worn out gland Loose gland 	<ul style="list-style-type: none"> Use brand new gland Change the stuffing bush Tighten the gland nuts
Noisy operation	<ul style="list-style-type: none"> Worn out motor or pump ball bearings Cavitation Worn out or misaligned coupling Operation in the far left or right of the performance curve 	<ul style="list-style-type: none"> Replace Close the delivery partially in order to reduce the capacity. Replace the coupling or align it Operate the pump at its label setting
Excessive increase in pump temperature	<ul style="list-style-type: none"> Pump and/or pipe can neither discharge, nor aspirate air Too low capacity 	<ul style="list-style-type: none"> Bleed completely the pump and the pipe Open more the valve
Vibration	<ul style="list-style-type: none"> Pump and/or pipe can neither discharge, nor aspirate air NPSH is too low Internal components of the pump are worn out System pressure is lower than the requested pressure level Coupling is misaligned Too much, too little or improper lubrication Rotor unbalanced Improper bearings 	<ul style="list-style-type: none"> Bleed completely the pump and the pipe Increase the liquid level Replace the worn out components Adjust the operating pressure to the label value Align the coupling In case of continuous overload, decrease the impeller diameter Change the oil, decrease or increase its quantity Balance the impeller again Use new bearings

Table 3: Possible Failures, Causes, Solutions

12. PUMP DIMENSIONS TABLE AND WEIGHTS

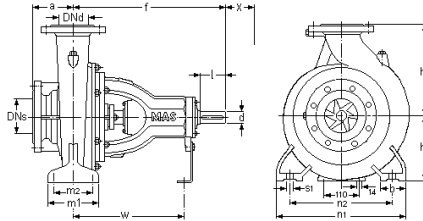

Figure 19: NM Pump Dimensions Figure

No	Pump Type		Flanges		Length		Height		Pump Feet Fixing Details							Shaft End			Weight kg
	EN 733	Added	DNs mm	DNd mm	a mm	f mm	h1 mm	h2 mm	b mm	m1 mm	m2 mm	n1 mm	n2 mm	s1 mm	W mm	d mm	l mm	X mm	
1	32-160		50	32	80	360	132	160	50	100	70	240	190	M12	260	24	50	65	37
2	32-200		50	32	80	360	160	180	50	100	70	240	190	M12	260	24	50	65	40
3		32-250	50	32	100	360	180	225	50	125	95	320	250	M12	260	24	50	80	45
4	40-160		65	40	80	360	132	160	50	100	70	240	190	M12	260	24	50	75	38
5	40-200		65	40	100	360	160	180	50	100	70	265	212	M12	260	24	50	75	44.5
6	40-250		65	40	100	360	180	225	65	125	95	320	250	M12	260	24	50	75	54.5
7	50-160		65	50	100	360	160	180	50	100	70	265	212	M12	260	24	50	80	41.5
8	50-200		65	50	100	360	160	200	50	125	95	265	212	M12	260	24	50	85	46.5
9	50-250		65	50	100	360	180	225	65	125	95	320	250	M12	260	24	50	85	54.5
10		50-315	80	50	100	470	225	280	80	160	120	360	280	M16	330	32	80	100	103
11	65-160		80	65	100	360	160	200	65	125	95	280	212	M12	260	24	50	100	44
12	65-200		80	65	100	360	180	225	65	125	95	320	250	M12	260	24	50	100	47.5
13	65-250		80	65	100	470	200	250	80	160	120	360	280	M16	340	32	80	100	77.5
14	65-315		80	65	125	470	225	280	80	160	120	400	315	M16	340	32	80	110	92
15		65-400	100	65	125	470	250	355	80	160	120	400	315	M16	340	32	80	110	125
16	80-160		100	80	125	360	180	225	65	125	95	320	250	M12	260	24	50	110	51
17	80-200		100	80	125	470	180	250	65	125	95	345	280	M12	340	32	80	110	75.5
18	80-250		100	80	125	470	200	280	80	160	120	400	315	M16	340	32	80	115	93
19	80-315		100	80	125	470	250	315	80	160	120	400	315	M16	340	32	80	120	107
20		80-400	100	80	125	530	280	355	100	200	150	500	400	M20	370	42	110	120	162
21		100-160	125	100	125	360	200	280	80	160	120	360	280	M16	260	24	50	120	-
22	100-200		125	100	125	470	200	280	80	160	120	360	280	M16	340	32	80	120	83
23	100-250		125	100	140	470	225	280	80	160	120	400	315	M16	340	32	80	130	95
24	100-315		125	100	140	470	250	315	80	160	120	400	315	M16	340	32	80	130	110
25	100-400		125	100	140	530	280	355	100	200	150	500	400	M20	370	42	110	130	168
26		125-200	150	125	140	470	250	315	80	160	120	400	315	M16	340	32	80	130	106.5
27	125-250		150	125	140	470	250	355	80	160	120	400	315	M16	340	32	80	140	105.5
28	125-315		150	125	140	530	280	355	100	200	150	500	400	M20	370	42	110	140	166.5
29	125-400		150	125	140	530	315	400	100	200	150	500	400	M20	370	42	110	140	189
30		150-200	200	150	160	470	280	355	100	200	150	500	400	M16	340	32	80	170	137.5
31		150-250	200	150	160	470	280	375	100	200	150	500	400	M16	340	32	80	140	137.5
32	150-315		200	150	160	530	280	400	100	200	150	550	450	M20	370	42	110	140	182.5
33	150-400		200	150	160	530	315	450	100	200	150	550	450	M20	370	42	110	140	210.5
34		150-500	200	150	180	700	400	525	110	250	200	620	500	M20	500	55	110	140	197

36		200-315	250	200	180	535	355	450	110	250	200	620	500	M20	410	42	110	160	201
36		200-400	250	200	180	710	400	500	110	250	200	620	500	M20	500	55	110	160	354
37		200-500	300	250	280	875	500	700	150	360	250	900	750	M28	560	65	140	320	615
38		250-315	300	250	240	725	400	525	140	300	240	620	500	M24	500	55	110	200	419
39		250-400	300	250	225	865	400	550	140	300	240	620	500	M24	600	65	140	200	510
40		250-500	300	250	280	875	500	700	150	360	290	900	750	M28	560	65	140	320	615
41		250-500A	300	250	280	875	500	700	150	360	290	900	750	M28	560	65	140	320	615
42		300-315A	300	300	275	810	425	600	140	300	240	620	500	M24	550	55	140	270	516
43		300-315	300	300	275	810	425	600	140	300	240	620	500	M24	550	55	140	270	516
44		300-400	350	300	275	865	450	630	150	360	290	800	650	M24	550	65	140	300	636
45		350-450	400	350	280	875	500	700	150	360	290	900	750	M24	560	65	140	300	755

Table 4: NM Pump Dimensions Table and Weights

13. TIGHTENING TORQUES

THREAD DIAMETER	TIGHTENING TORQUE MAX (N m)	
	Property Classes	
	8.8	10.9
M4	3.0	4.4
M5	5.9	8.7
M6	10	15
M8	25	36
M10	49	72
M12	85	125
M14	135	200
M16	210	310
M18	300	430
M20	425	610
M22	580	820
M24	730	1050
M27	1100	1550
M30	1450	2100
M33	1970	2770
M36	2530	3560

Table 5: Tightening Torques Table

14. FORCES AND MOMENTS AT THE PUMP FLANGES

All of the applied load sif not reached the maximum allowable value, to provide that the following additional conditions, one of these loads may exceed the normal limit:

- Any component of a force or a moment, must be limited 1.4 times of the maximum allowable value,
- The actual force sand moments acting on each flange, should provide the following formula:

$$\left(\frac{\sum |F|_{\text{actual}}}{\sum |F|_{\text{maximum allowable}}} \right)^2 + \left(\frac{\sum |M|_{\text{actual}}}{\sum |M|_{\text{maximum allowable}}} \right)^2 \leq 2$$

In here, $\sum F$ and $\sum M$ are arithmetic sum of the loads for each flange at the pump level, without regard of the algebraic signs of the actual and maximum allowable values.

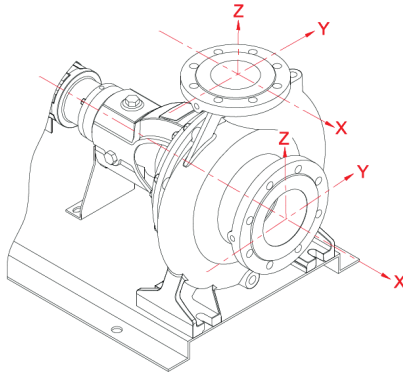

PUMP TYPE	FORCES								MOMENTS					
	DN FLANGE		SUCTION FLANGE			DISCHARGE FLANGE			SUCTION FLANGE			DISCHARGE FLANGE		
	SS	DS	N			N			Nm			Nm		
			F _y	F _z	F _x	F _y	F _z	F _x	M _y	M _z	M _x	M _y	M _z	M _x
NM 32-160	50	32	500	450	550	283	350	300	333	383	467	250	283	367
NM 32-200														
NM 32-250														
NM 40-160	65	40	617	567	700	333	417	367	367	400	500	300	350	433
NM 40-200														
NM 40-250														
NM 50-160	65	50	617	567	700	450	550	500	367	400	500	333	383	467
NM 50-200														
NM 50-250														
NM 50-315	80	65	750	683	833	567	700	617	383	433	533	367	400	500
NM 65-160														
NM 65-200														
NM 65-250	100	80	1000	900	1117	683	833	750	383	433	533	383	433	533
NM 65-315														
NM 65-400														
NM 80-160	125	100	1183	1067	1317	900	1117	1000	417	483	583	417	483	583
NM 80-200														
NM 80-250														
NM 80-315	150	125	1500	1350	1667	1067	1317	1183	500	633	700	500	633	700
NM 80-400														
NM 100-200														
NM 100-250	200	150	2286	1800	2233	1350	1667	1500	583	683	833	583	683	833
NM 100-315														
NM 100-400														
NM 125-200	250	200	2483	2250	2783	2057	2552	2286	876	1010	1238	876	1010	1238
NM 125-250														
NM 125-315														
NM 125-400	300	250	3410	3067	3810	2571	3181	2838	1200	1391	1695	1200	1391	1695
NM 150-200														
NM 150-250														
NM 150-315	300	300	3410	3067	3810	3067	3810	3410	1200	1391	1695	1638	1886	2305
NM 150-400														
NM 150-500														
NM 200-315	400	350	4552	4095	5067	3581	4438	3981	2629	3029	3695	2095	2419	2952
NM 200-400														
NM 200-500														
NM 250-315	300	250	3410	3067	3810	2571	3181	2838	1200	1391	1695	1200	1391	1695
NM 250-400														
NM 250-500														
NM 250-500A	300	300	3410	3067	3810	3067	3810	3410	1200	1391	1695	1638	1886	2305
NM 300-315														
NM 300-315A														
NM 300-400	400	350	4552	4095	5067	3581	4438	3981	2629	3029	3695	2095	2419	2952
NM 350-450														

Table 6 - Forces and Moments at The Pump Flanges

Forces at the pump flanges were calculated according to TS EN ISO 5199 standard. The calculations are valid for the materials of cast iron and bronze. Forces and moments at the flanges that made of stainless material will be approximately twice as moments in the table.

15. SAMPLE PLUMBING

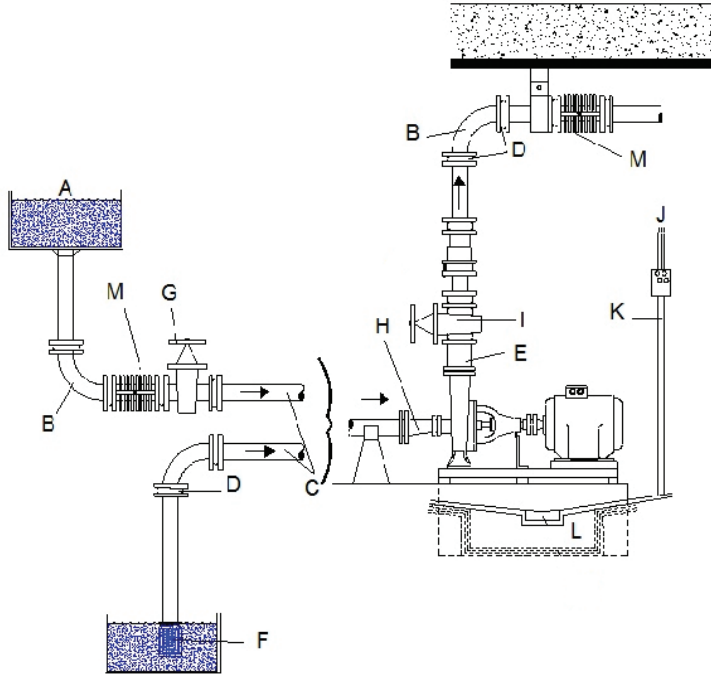

Figure 20: Sample Plumbing

- A. Tank
- B. Long radius elbow
- C. Minimum slope is 2 cm/m
- D. Fittings, flanges etc.
- E. Non-return valve
- F. Foot valve
- G. Suction valve
- H. Reducer
- I. Discharge valve
- J. Electrical connection
- K. Insulated cable
- L. Concrete foundation
- M. Compensator

16. NM SECTIONAL DRAWING AND PARTS LIST

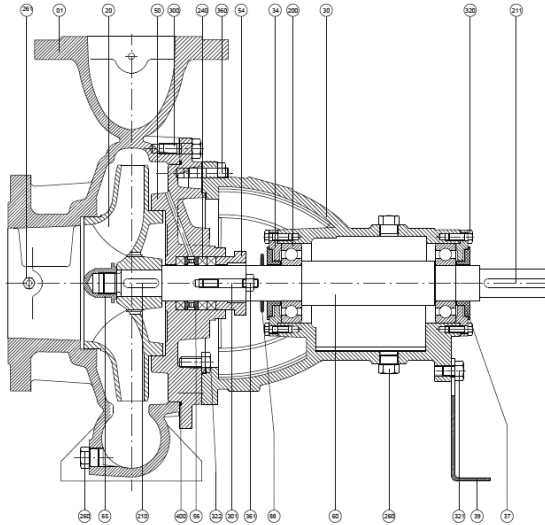

Figure 21-a: Design with the SoftPacking

Part No	Name of the Part (Standard pump parts)	Part No	Name of the Part (optional parts)
01	Volute casing	03a	Back cover (for cooling sleeve)
03	Back cover (stuffing box)	05	Wear ring (suction side)
20	Impeller	06	Wear ring (discharge side)
30	Bearing housing	11	Cooling Jacket
35	Bearing cover	58	Cover for mechanical seal (bellow type)
37	Deflector	59	Cover for mechanical seal (spring actuated)
39	Supporting pedestal	60a	Shaft Jacket (in sleeve application)
54	Gland	67	Throttle bush for mechanical seal (bellow type)
56	Lantern ring	68	Throttle bush for mechanical seal (spring actuated)
60	Shaft	70	Shaft Jacket (for soft packing)
65	Impeller nut	71	Shaft Jacket (for mechanical seal)
200	Rolling bearing	213	Impeller key (in shaft jacket application)
210	Impeller key	250	Mechanical seal (bellow type) MG1
211	Coupling key Gland bush	251	Mechanical seal (spring actuated) M3
240	Soft packing	265	Cooling Jacket piping
260	Solid plug	403	Cooling Jacket O-ring
300	Casing stud	404	Shaft Jacket O-ring
301	Gland stud	405	O-ring (for mechanical seal cover)
320	Cover bolt	410	Cooling Jacket gasket
321	Pedestal bolt		
360	Casing stud nut		
361	Gland stud nut		
400	O-ring (casing)		

Table 7: NM Sectional Part List

17. ALTERNATIVE APPLICATIONS

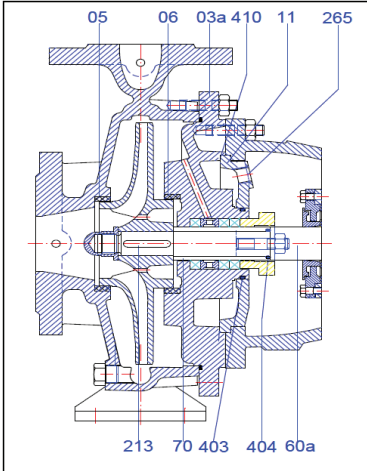

Figure 21-b: Design with Cooling Jacket

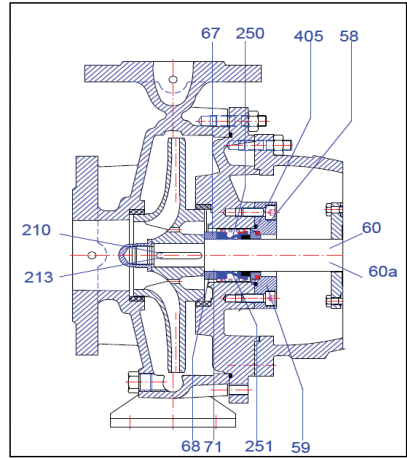

Figure 21-c: Mechanical Seal Design (Bellow Type)

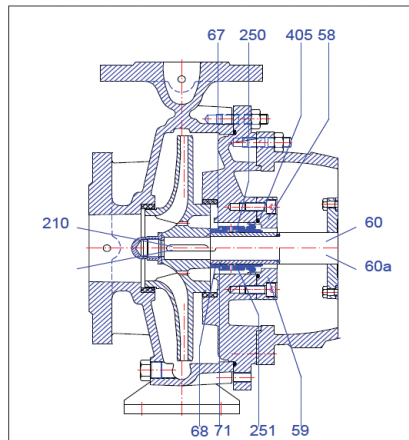

Figure 21-d: Mechanical Seal Design (Spring Actuated)

18. NM DRAWING FOR DISMANTLING

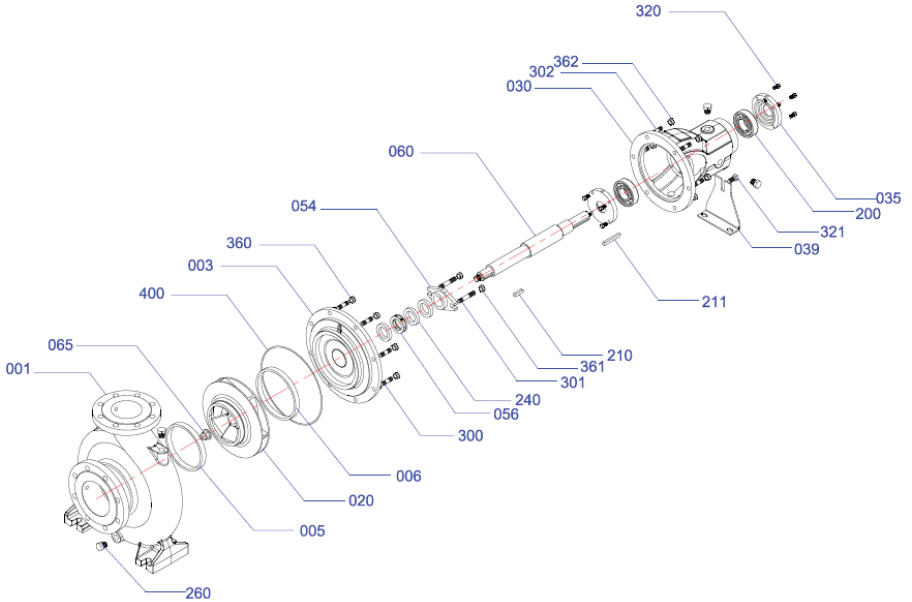

Figure 22: NM Drawing For Dismantling

Part No	Part Name	Part No	Part Name
01	Volute Casing	210	Coupling Key
03	Stuffing Box	211	Impeller Key
05	Wear Ring (Suction Side)	240	Soft Packing
06	Wear Ring (Discharge Side)	260	Plug
20	Impeller	300	Stud
30	Bearing Housing	301	Stud for Gland
35	Bearing Cover (Outside)	302	Nut for Gland
39	Supporting Pedestal	320	Hexagonal Bolt
54	Gland	321	Hexagonal Bolt
56	Lantern Ring	360	Hexagonal Bolt
60	Pump Shaft	361	Hexagonal Nut for Gland
65	Impeller Nut	362	Hexagonal Nut
200	Ball Bearing	400	O-Ring
201	Ball Bearing		

Table 8: NM Drawing For Dismantling Part List

19. NM SERIES MEI VALUE TABLE

1450 rpm	Speed (rpm)	MEI
NM32-160	1450	0.6
NM 32-200	1450	0.7
NM 32-250	1450	0.5
NM 40-160	1450	0.4
NM 40-200	1450	0.7
NM 40-250	1450	0.7
NM 50-160	1450	0.4
NM 50-200	1450	0.6
NM 50-250	1450	0.6
NM 50-315	1450	0.5
NM 65-160	1450	0.6
NM 65-200	1450	0.5
NM 65-250	1450	0.5
NM 65-315	1450	0.6
NM 65-400	1450	0.6
NM 80-160	1450	0.4
NM 80-200	1450	0.4
NM 80-250	1450	0.4
NM 80-315	1450	0.6
NM 80-400	1450	0.4
NM 100-160	1450	0.5
NM 100-200	1450	0.4
NM 100-250	1450	0.5
NM 100-315	1450	0.5
NM 100-400	1450	0.4
NM 125-200	1450	0.4
NM 125-250	1450	0.5
NM 125-315	1450	0.5
NM 125-400	1450	0.6
NM 150-200	1450	0.4
NM 150-250	1450	0.4
NM 150-315	1450	0.4
NM 150-400	1450	0.6
NM 200-315	1450	0.4
NM 250-315	1450	0.4
NM 300-315	1450	0.4
NM 300-315A	1450	0.4

Table 9: NM MEI Table (1450 rpm)

2900 rpm	Speed (rpm)	MEI
NM 32-160	2900	0.6
NM 32-200	2900	0.7
NM 32-250	2900	0.5
NM 40-160	2900	0.4
NM 40-200	2900	0.7
NM 40-250	2900	0.7
NM 50-160	2900	0.4
NM 50-200	2900	0.6
NM 50-250	2900	0.6
NM 50-315	2900	0.5
NM 65-160	2900	0.6
NM 65-200	2900	0.5
NM 65-250	2900	0.5
NM 65-315	2900	0.6
NM 80-160	2900	0.6
NM 80-200	2900	0.4
NM 80-250	2900	0.4
NM 80-315	2900	0.4
NM 100-160	2900	0.6
NM 100-200	2900	0.4
NM 100-250	2900	0.5
NM 100-315	2900	0.4

Table 10: NM MEI Table (2900 rpm)

20. FIGURE LIST

		Page No
Figure 1	Pump Label	4
Figure 2	Transport of Pump Group	7
Figure 3	A Typical Concrete Foundation	7
Figure 4	The Control of the Coupling Alignment in Horizontal and Vertical Planes	8
Figure 5	Paralel Axis Misalignment in Vertical Plane and Its Correction	8
Figure 6	Angular Misalignment in Vertical Plane and Its Correction	8
Figure 7	Parallel Axis Misalignment in Horizontal Plane and Its Correction	8
Figure 8	Angular Misalignment in Horizontal Plane and Its Correction	9
Figure 9	Piping System	10
Figure 10	Electric Connection Diagram	10
Figure 11	Disassembly - 1	14
Figure 12	Disassembly -2	14
Figure 13	Disassembly -3	14
Figure 14	Disassembly -4	15
Figure 15	Disassembly -5	15
Figure 16	Coupling Guard Assembly -1	16
Figure 17	Coupling Guard Assembly -2	16
Figure 18	Coupling Guard Assembly -3	16
Figure 19	NM Pump Dimensions Figure	18
Figure 20	Sample Plumbing	22
Figure 21-a	Design with the Soft Packing	23
Figure 21-b	Design with Cooling Jacket	24
Figure 21-c	Mechanical Seal Design (Bellow Type)	24
Figure 21-d	Mechanical Seal Design (Spring Actuated)	24
Figure 22	NM Drawing For Dismantling	25

22. TABLE LIST

		Page No
Table 1	Spare Part List	13
Table 2	Sound Pressure Level	14
Table 3	Possible Failures, Causes, Solutions	17
Table 4	NM Pump Dimensions Table and Weights	19
Table 5	Tightening Torques Table	19
Table 6	Forces and Moments at The Pump Flanges	21
Table 7	NM Sectional Part List	23
Table 8	NM Drawing For Dismantling Part List	25
Table 9	NM MEI Table (1450 rpm)	26
Table 10	NM MEI Table (2900 rpm)	26



Head Office / Center Service

Aydınlı Mah. Birlik OSB. 1 Nolu Cd.

No: 17 Tuzla 34953 İstanbul / Turkey

Phone: +90 216 456 47 00 Fax: +09 216 455 14 24

Customer Service: +90 850 88 88 627

e-mail: info@masgrup.com

www.masgrup.com